

ALUMINIUM CLAD LIFT & SLIDE DOOR

TITLE

ELEVATION DRAWING

DRAWING No.

LS-A-78/01

DATE

2018/06/06

SCALE

CONSTRUCTION DETAILS

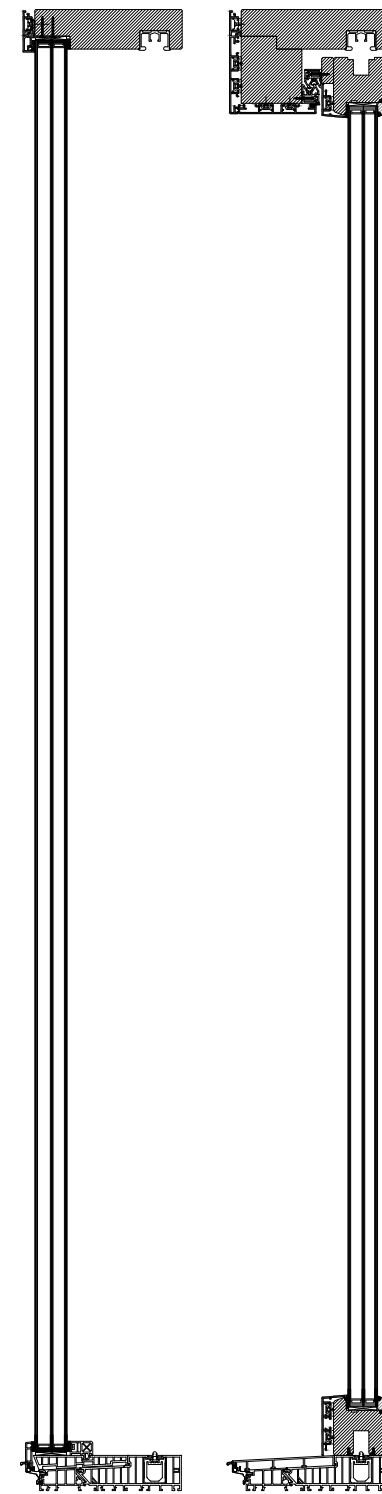
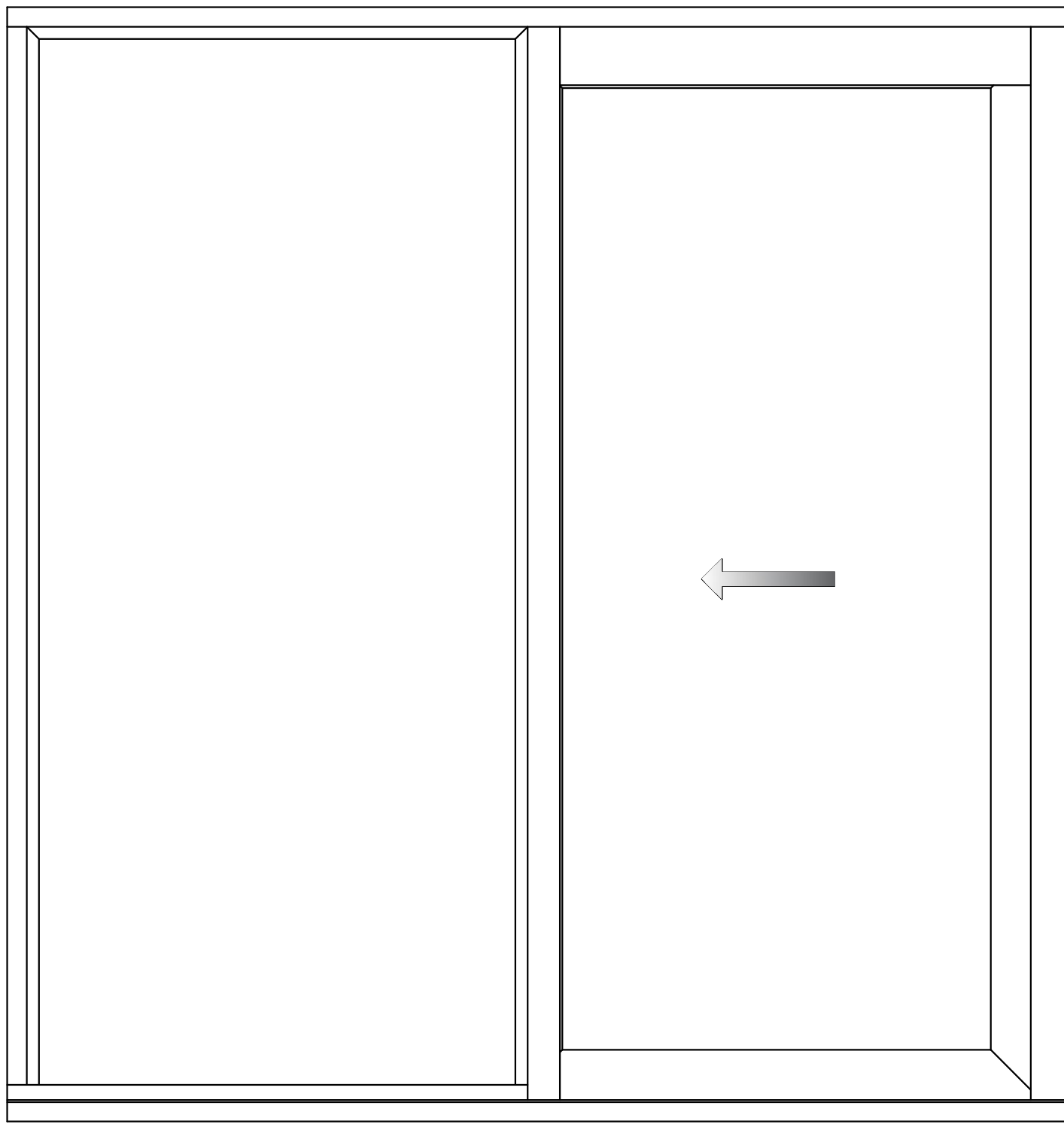

Material	Manufactured in selected engineered laminated pine or hardwood, sourced from sustainable and managed forestry (FSC or PFEC certified)
Mechanism	Sash is lifted with the comfort gear and slides the bottom rail with the help of wheels, which can carry up to 400kg sash weight
Security (optional)	Fully tested to Secure by design standards PAS 24:2012
Weatherseal	The window is fully weather sealed to BS EN 6375-1 2009
Glass	The window is factory glazed and can take dual or triple sealed units up to 48mm thickness
Thermal Performance	Thermal performance is calculated by the standards of EN ISO 10077-1:2006 and this window achieves a U-value of 1.4 W/m ² K or better
Fittings	Lift and Slide door handle coordinated with the sash weight and hardware, recessed pull handle externally with options in colour and finish. Locking cylinder is an option
Factory Finishing	To ensure the smooth operation and optimum performance of the window, we apply 3 coats of sprayed applied microporous water based paint system

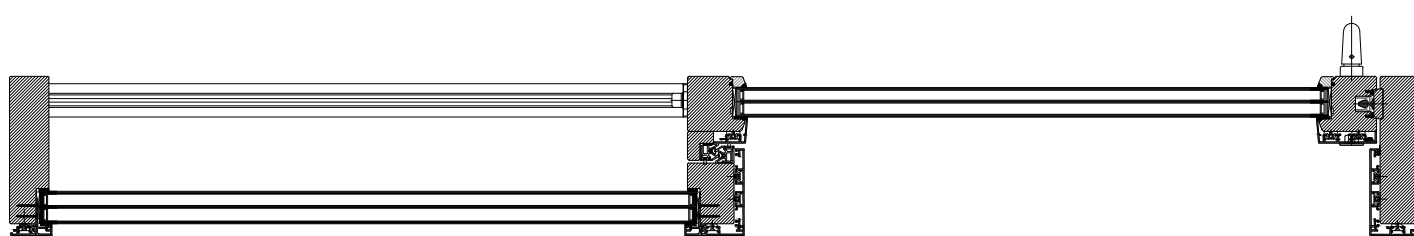

FENSTER UAB
 Kirtimų 47, LT-02244,
 Vilnius, Lithuania
 Phone.: + 370 5 206 0987
 Mob.: +370 682 01711
 Fax.: +370 5 206 0986
 E-mail: info@zylefenster.com
 www.zylefenster.com



ALUMINIUM CLAD LIFT & SLIDE DOOR

TITLE

VERTICAL SECTION

DRAWING No.

LS-A-78/02

DATE

2018/06/06

SCALE

1:2 @ A3

CONSTRUCTION DETAILS

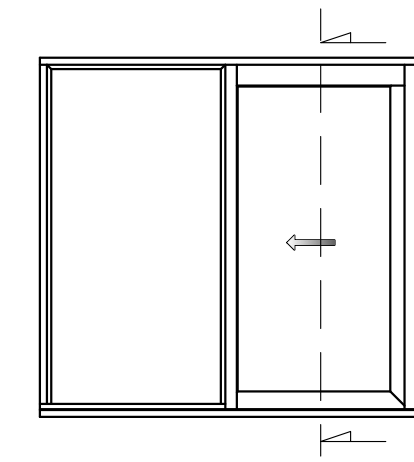
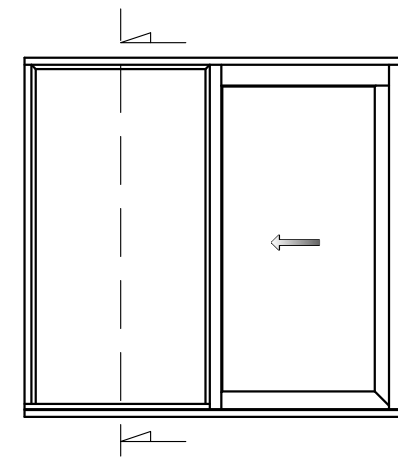
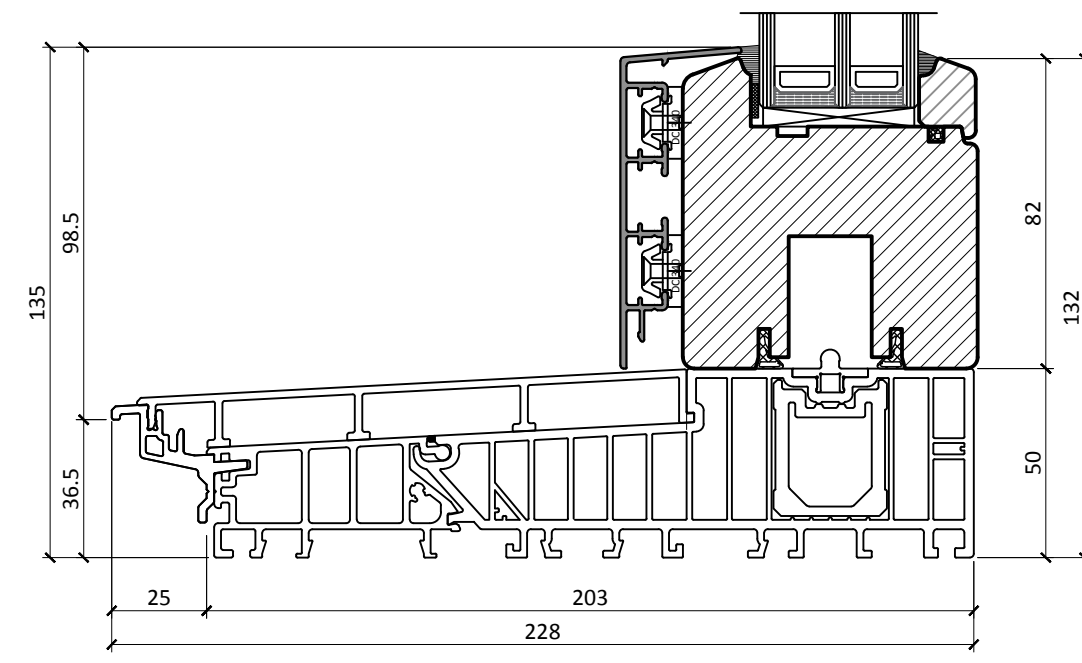
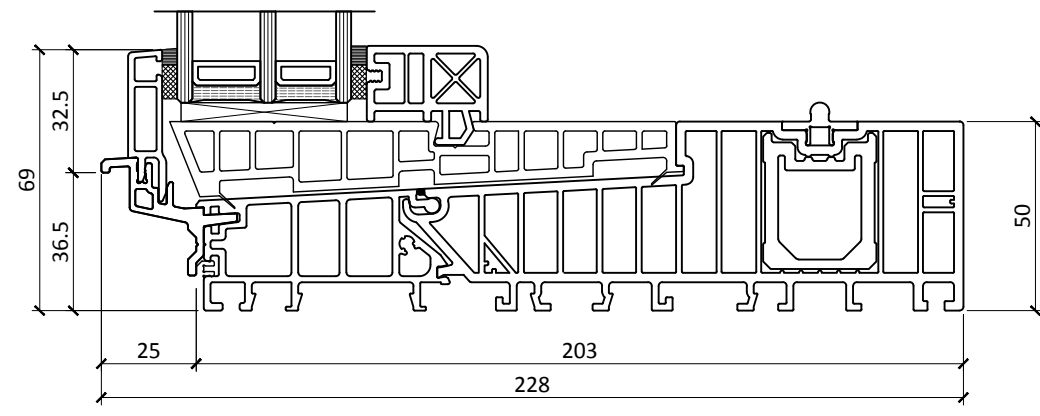
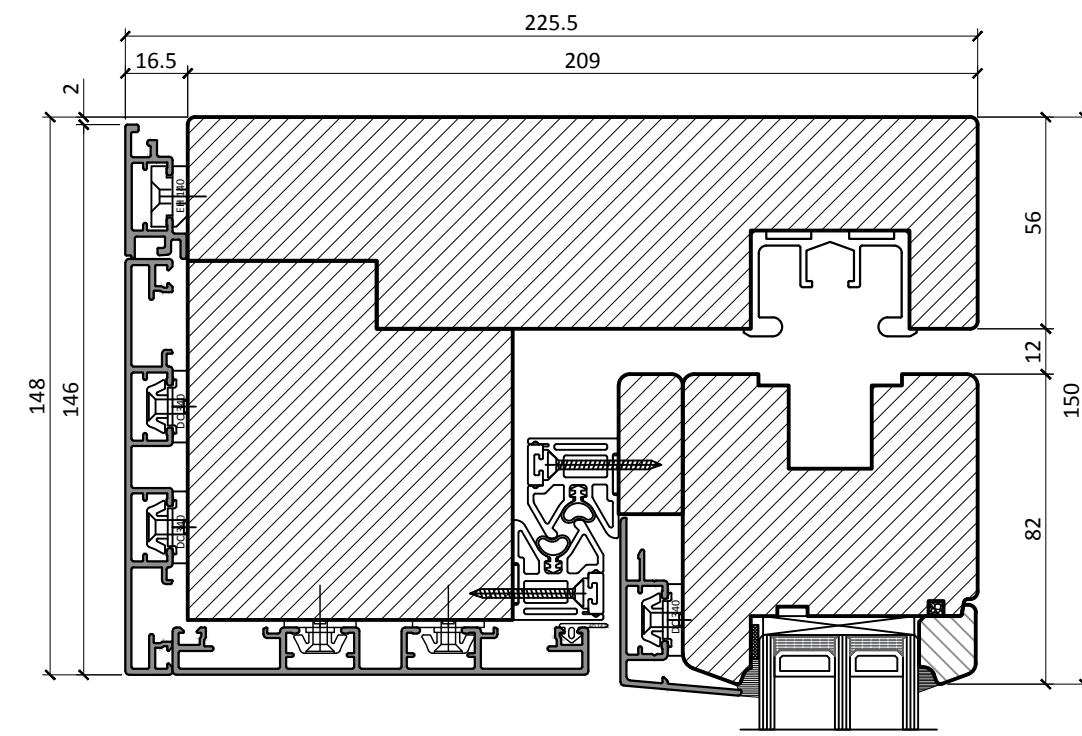
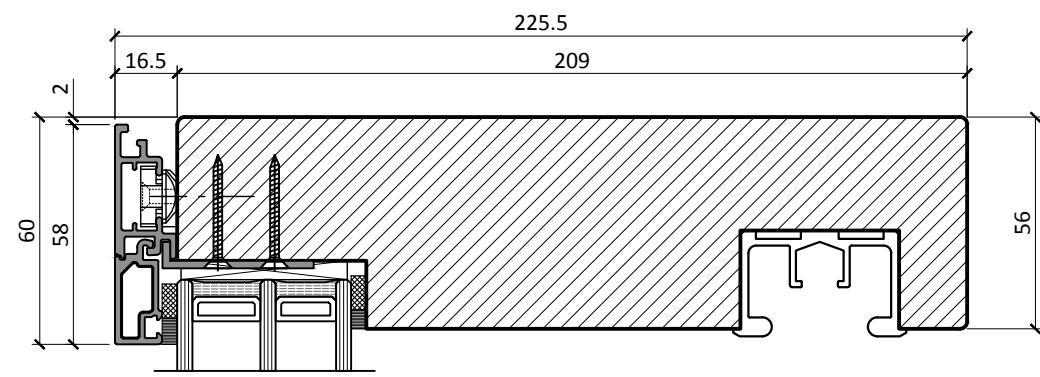

FENSTER UAB
 Kirtimų 47, LT-02244,
 Vilnius, Lithuania
 Phone.: + 370 5 206 0987
 Mob.: +370 682 01711
 Fax.: +370 5 206 0986
 E-mail: info@zylefenster.com
 www.zylefenster.com



ALUMINIUM CLAD LIFT & SLIDE DOOR

TITLE

HORIZONTAL SECTION

DRAWING No.

LS-A-78/03

DATE

2018/06/06

SCALE

1:1.5 @ A3

CONSTRUCTION DETAILS

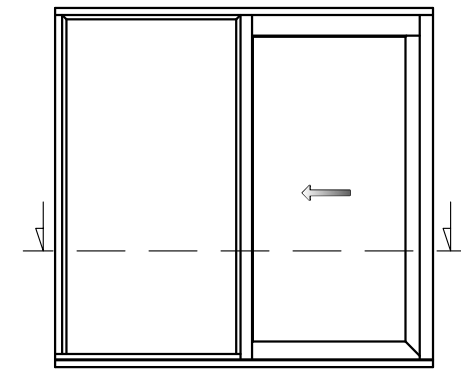
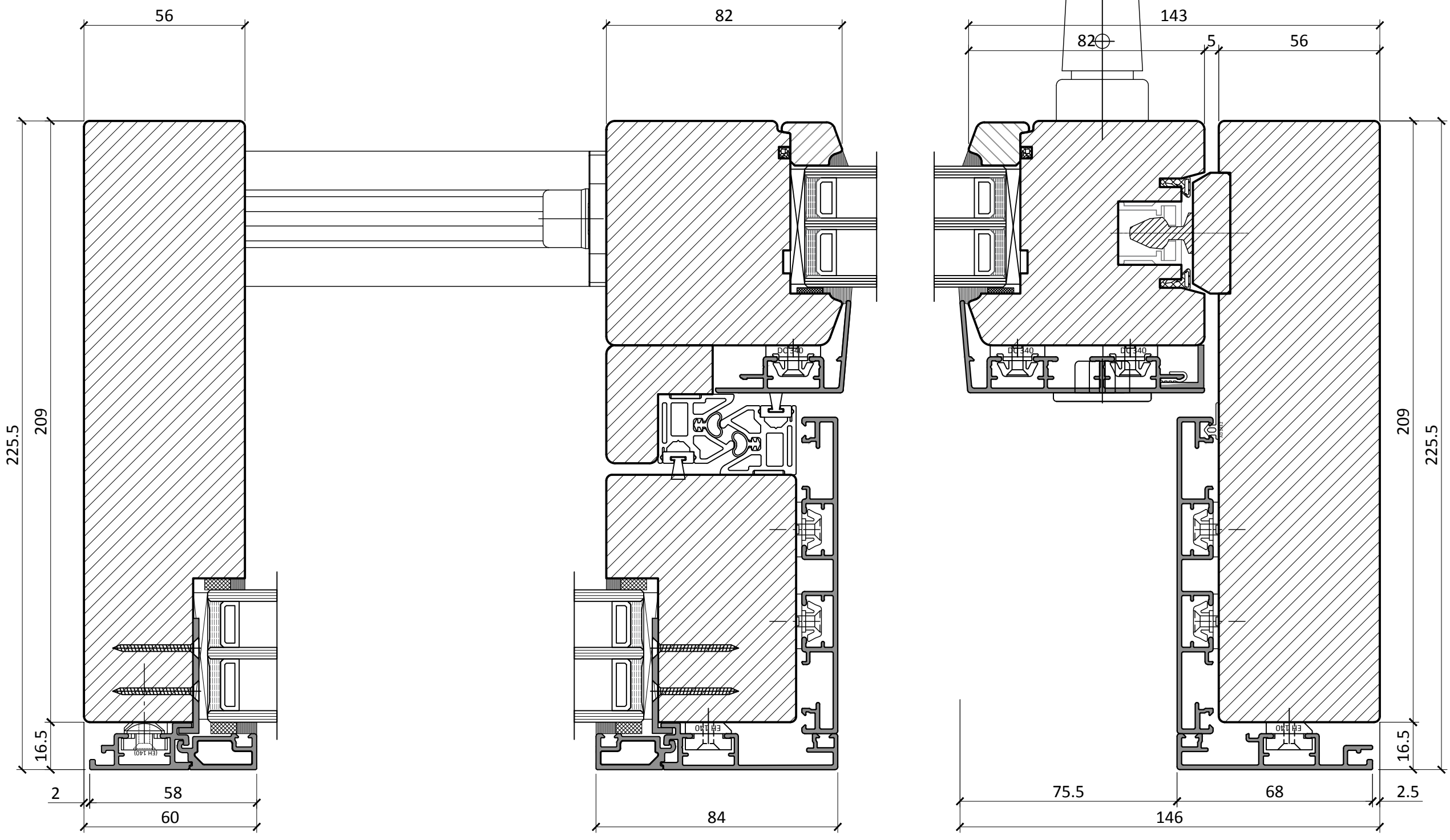

FENSTER UAB
 Kirtimų 47, LT-02244,
 Vilnius, Lithuania
 Phone.: + 370 5 206 0987
 Mob.: +370 682 01711
 Fax.: +370 5 206 0986
 E-mail: info@zylefenster.com
 www.zylefenster.com



ALUMINIUM CLAD LIFT & SLIDE DOOR

TITLE

HORIZONTAL SECTION

DRAWING No.

LS-A-78/04

DATE

2018/06/06

SCALE

CONSTRUCTION DETAILS

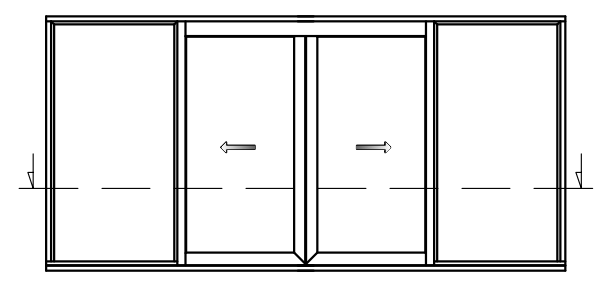
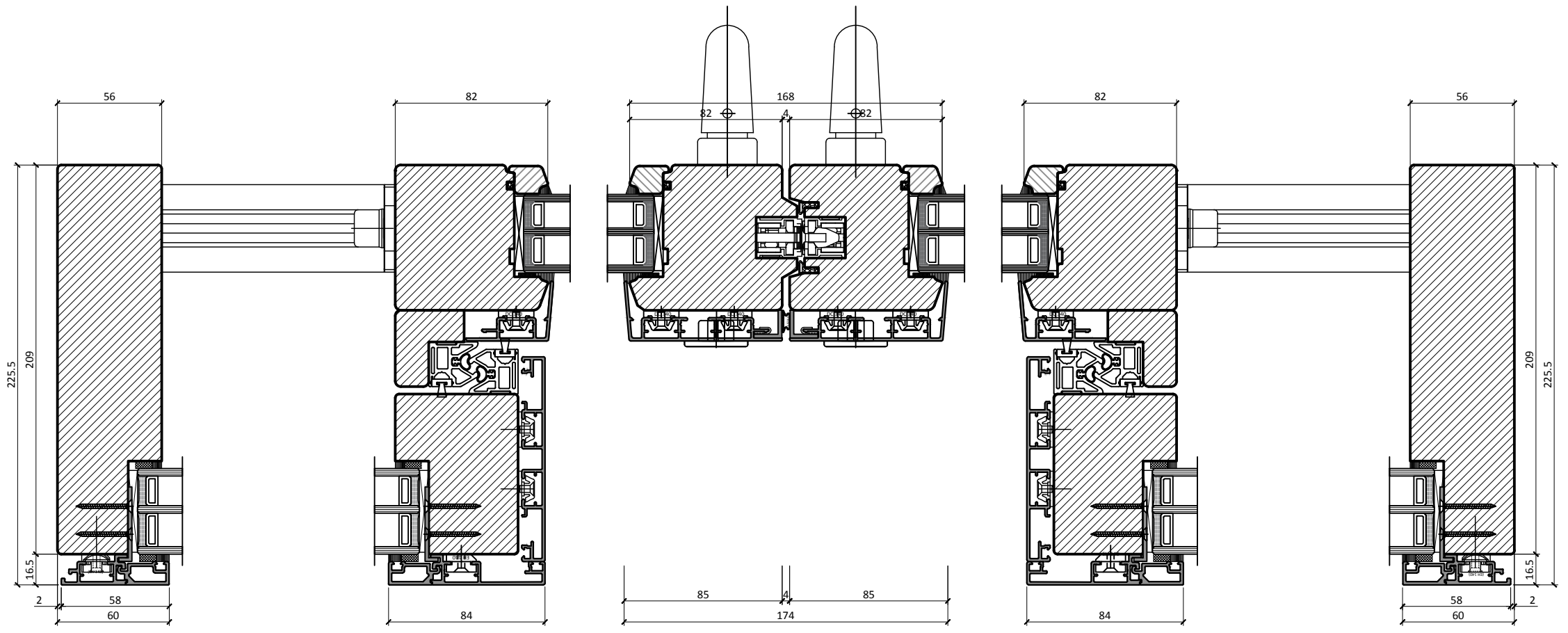
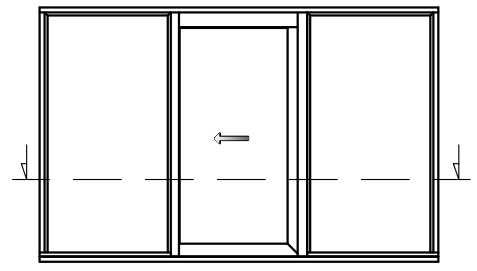
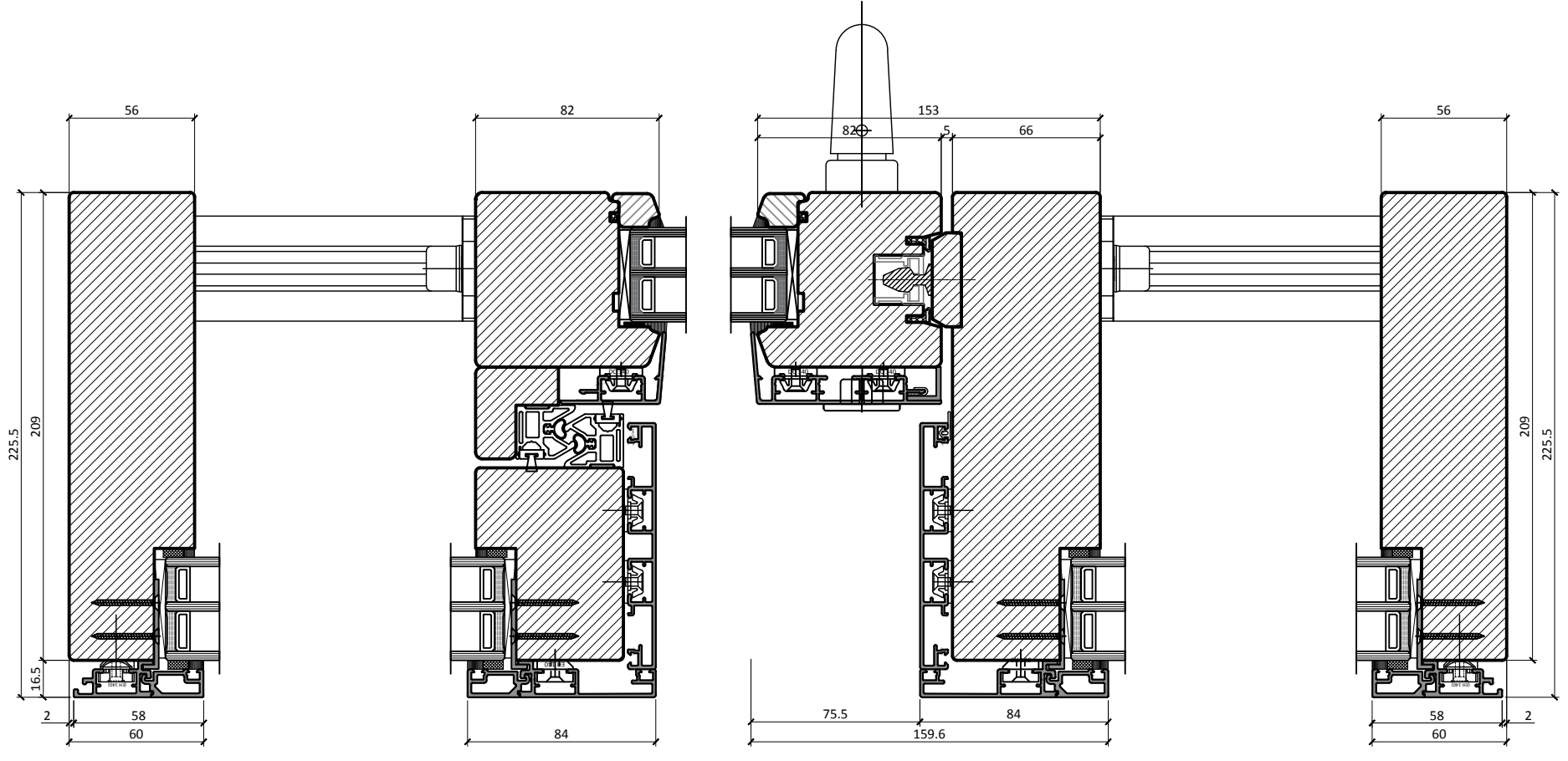

FENSTER UAB
 Kirtimų 47, LT-02244,
 Vilnius, Lithuania
 Phone.: + 370 5 206 0987
 Mob.: +370 682 01711
 Fax.: +370 5 206 0986
 E-mail: info@zylefenster.com
 www.zylefenster.com

